

ResearchGate

Cut away view of the first Cband ...



Images may be subject to copyright. [Learn More](#)

Related images

[See more](#)

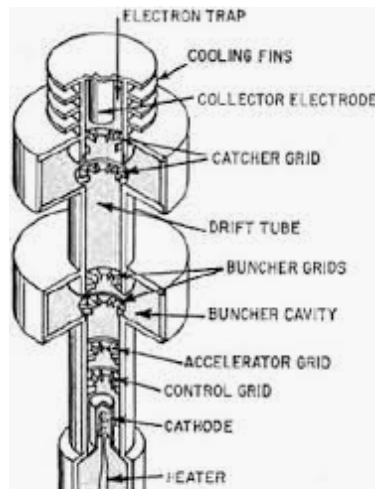
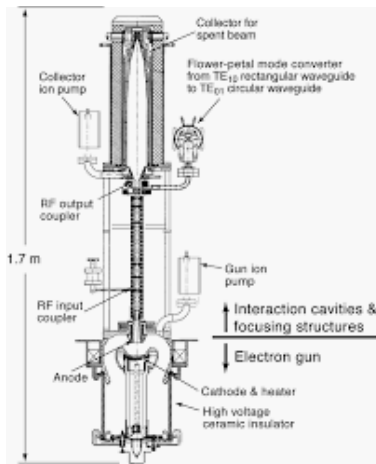

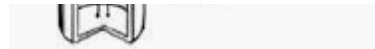

Klystron: Tube for Outer Space, F...
rfcafe.com

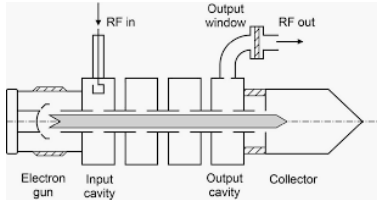

Klystrons (Chapter 13) - Microwa...
cambridge.org

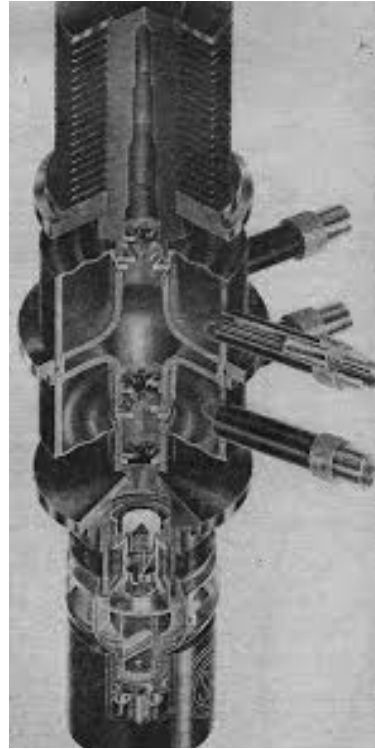

Klystron: Tube of the Future, Oct...
rfcafe.com

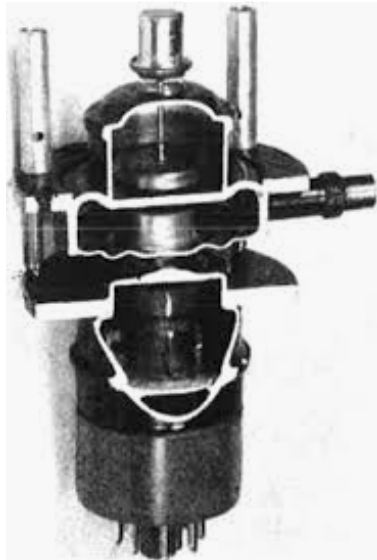

Microwaves for the "Ham", Augus...
rfcafe.com

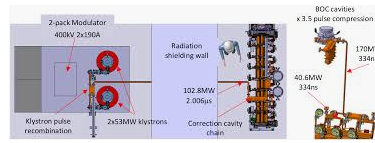

The Compact Linear Collider (CLI...
groundai.com

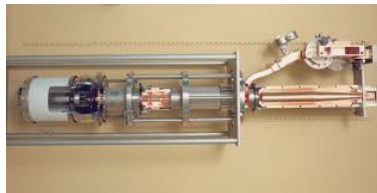

Deep Science
slac.stanford.edu

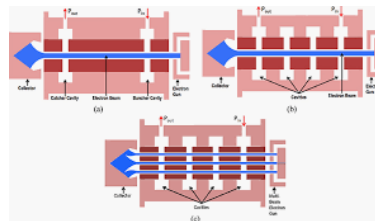

Qualitative description of convent...
iopscience.iop.org

[See more](#)

[Send feedback](#)

[Get help](#)

[Collections](#)